





 **BioLite** x MPOWERD®

In 2024, MPOWERD will join the BioLite family in a merger that not only provides our customers with more clean energy solutions, but also expands and amplifies our mission.

This Spring 2025 product catalog reflects the combined global impact and product portfolio of BioLite and MPOWERED.

LIGHT

HEADLAMPS

HeadLamp 325	21
NEW Dash 450	23
HeadLamp 800 Pro	25

USB LANTERNS

AlpenGlow 500	29
AlpenGlow 250	31
AlpenGlow Mini	33

NEW SOLAR INFLATABLE LANTERNS

Luci Original Clear	37
Luci Original Matte	39
Luci Original Color	41
Luci Charge 150	43
Luci Charge 360	45
Luci Candle	47
Luci Emergency	49

NEW SOLAR STRING LIGHTS

Solar String 18' Warm White	53
Solar String 18' Color	55
Solar String 44' Warm White	57
Site Lights	59

INSTALLED SOLAR

SolarHome 625	61
---------------	----

NEW SOLAR UTILITY

Solar FlexLight	63
-----------------	----

CHARGE

POWER STATIONS

BaseCharge 1500+	67
BaseCharge 600+	69
Cables & Accessories	70

USB POWERBANKS

Charge 100 Max	73
Charge 80 PD	75
Charge 40 PD	76
Charge 20 PD	77

SOLAR PANELS

SolarPanel 100	81
SolarPanel 10+	82
SolarPanel 5+	83

COOK

PORTABLE STOVES

CampStove Complete Cook Kit	89
CampStove 2+	91
CampStove KettlePot & Coffee Set	92
CampStove Portable Grill	93

CAMPFIRE EVOLVED

FirePit+	97
FirePit Accessories	98

OUR MODEL	8
ENERGY FOR ALL	10
PEOPLE, PLANET, PARTNERS	12
PRODUCT GLOSSARY	100
TRAINING & SUPPORT	102

Our Model

Parallel Innovation

Using a unique business model called **Parallel Innovation**, our team develops core energy technologies that are applicable to two distinct customer segments:



Off-grid households
in emerging markets in
Africa and Asia.



Outdoor recreation customers
seeking renewable and rechargeable
ways to cook, charge, and light.

Energy For All

Everyone deserves access to clean, reliable, and affordable energy.

Energy sits at the center of our lives, keeping us safe, productive, and connected. Health, education, opportunity, adventure – all of it is shaped by the invisible power of energy.

For those we serve in the outdoor markets, we are here to introduce you to the best damn rechargeables in the world. Beautiful, usable, and high-performing, our products enable you to leave fossil fuels and disposable batteries behind.

For those we serve in emerging markets, we have the humbling opportunity to be a household's first step onto the energy ladder: an extra hour of study after sunset, a charged phone ready to make mobile payments, a family dinner cooked without the worry of inhaling smoke.

These seemingly small moments are the very essence of what drives us at BioLite.

Every purchase directly impacts our mission and our ability to deliver safe energy around the world. Choosing BioLite is choosing a brighter future for both people and planet. Thank you for being a part of this journey.



PEOPLE

Over 13 million people are living safer, brighter lives thanks to BioLite products.

Improved education, running a small business, dinner without stinging smokey eyes, watching the big football match – all these moments are made possible through BioLite energy solutions. Every purchase helps this number grow.



 **13.3 million**
people impacted

PLANET

We're not just carbon neutral - we actively prevent carbon from hitting the atmosphere.

BioLite clean cookstoves reduce both fuel consumption and toxic emissions, earning verified carbon credits. The result is healthier homes and a healthier planet.



 **2,258,158**
tons of CO2 avoided

PARTNERS

Distributor and humanitarian channels enable us to work on both market-building and direct relief efforts around the world.

Thanks to our vetted network of last-mile partners, we are able to create true impact by getting products to people who want it and need it. From non-profits to regional businesses, our reach is made possible by the on-the-ground knowledge of our partners.



 **700+**
humanitarian & distribution partners

Proudly Carbon Neutral Since 2012 **Proudly Calling Others To Act Today.**

BioLite is the proud co-creator of Climate Neutral, an independent non-profit with a mission to address global climate change by recruiting and enabling companies to measure, reduce, and offset 100% of their carbon emissions immediately. Climate Neutral certifies brands using a rigorous but simple process, and supports certified companies through the use of the “Certified Climate Neutral” logo.

To learn more about BioLite's own carbon footprinting process, download our 2023 Impact Report:

[BioLiteEnergy.com/Impact2023](https://www.bioliteenergy.com/Impact2023)

To learn more about Climate Neutral, visit:

[ClimateNeutral.org](https://www.ClimateNeutral.org)





LIGHT

HEADLAMPS

HeadLamp 325

NEW Dash 450

HeadLamp 800 Pro

USB LANTERNS

AlpenGlow 500

AlpenGlow 250

AlpenGlow Mini

NEW SOLAR INFLATABLE LANTERNS

Luci Original Matte

Luci Original Clear

Luci Original Color

Luci Charge 150

Luci Charge 360

Luci Emergency

Luci Candle

NEW SOLAR STRING LIGHTS

Solar String 18' Warm White

Solar String 18' Color

Solar String 44' Warm White

Solar String 44' Color

INSTALLED SOLAR

SolarHome 625

NEW SOLAR UTILITY

Solar FlexLight

INSIDE THE DESIGN

HeadLamp Series

Our line of HeadLamps are not only designed for peak performance, the proprietary construction delivers the best fit of any headlamp on the market.

3D SLIMFIT CONSTRUCTION

By integrating our electronics into the fabric with a custom molded housing, we pack all your lighting into an ultra-thin facing that is designed to fit as seamlessly as a contact lens.

Our headlamps move with you as a single unit and you soon forget it's even there.

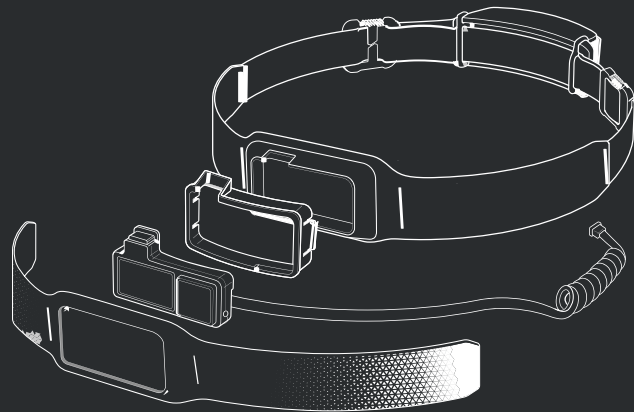



HeadLamp 325

HPB0310
MIDNIGHT GREY

HPB0311
OCEAN TEAL

HPB0312
EMBER YELLOW

The End of Disposable Batteries Starts Here

A minimalist design that maximizes comfort and fit, HeadLamp 325 is a compelling entry into the rechargeable landscape. Delivering 325 lumens, four lighting modes, and weighing only 50 grams, this generalist headlamp is ready to go head-to-head with alkalines – and win.

 3D SlimFit Construction

 USB Rechargeable

 4 Modes, Including Dimmable Red

 Weighs Only 50g



TECH SPECS

LUMENS
325 Lm

BURN TIME (HOURS)
40 LO/3 HI

WATER RESISTANCE
IPX4

BATTERY
700 mAh,
USB Rechargeable

WEIGHT
1.76 oz (50 g)

MODES

 Red Flood + Dimming

 Red Strobe

 White Strobe

 White Spot + Dimming

BEAM DISTANCE



Spot



Dash 450

NEW IN 2025





HPA0411
MIDNIGHT GREY

HPA0410
OCEAN TEAL

HPA0412
EMBER RED

The Ultimate Rechargeable Head Light For Runners

An update to the cult-favorite headlamp within the running world, Dash 450 delivers a perfect no-bounce fit with high-performance illumination. Featuring improved beam optics for route visibility, new reflective graphics, and a balanced rear red light, see and be seen whether you're on the road or the trail. Log miles with a near weightless feel thanks to the award-winning 3D SlimFit construction, moisture wicking band, and an ultra-slim front measuring only 9mm thick.

-  **3D SlimFit Construction**
-  **USB-C Charge In**
-  **Weighs Only 78g**
-  **Rear Red Flood & Strobe**



TECH SPECS

LUMENS

450 Lm

BURN TIME (HOURS)

40 LO/3 HI

WATER RESISTANCE

IPX4

BATTERY

1000 mAh,
USB-C Rechargeable

WEIGHT

2.75 oz (78 g)

MODES

-  **Red Flood + Dimming**
-  **White Flood + Dimming**
-  **White Strobe**
-  **White Spot + Dimming**
-  **Red Rear Strobe**

BEAM DISTANCE

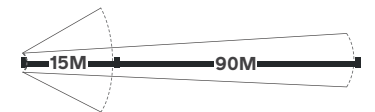







HeadLamp 800 Pro

HPC0201
MIDNIGHT GREY

High Performance Light With A High Performance Fit

Go further and stay brighter with the Pro-Level HeadLamp 800. Utilizing 3D SlimFit construction, this hands-free light packs serious lumens and rechargeable power into a compact profile with an unprecedented no-bounce fit. With key features including a 800 lumen Burst Mode, Constant Brightness Setting, and a red rear light, this HeadLamp is ready to match your own epic performance.

-  3D SlimFit Construction
-  USB Rechargeable
-  Constant Brightness Mode
-  Rear Red Flood & Strobe
-  Run Forever Cable Included



TECH SPECS

LUMENS

800 Lm BURST
500 Lm HIGH
5 Lm HOW

BURN TIME (REGULATED)

150 LO/7 HI

BURN TIME (CONSTANT)

150 LO/2 HI

ADDITIONAL RESERVE

+8 Hours at 5 Lm

BATTERY

3,000 mAh,
USB Rechargeable

WEIGHT

5.3 oz (150 g)

MODES

 Red Rear
Flood
+Dimming

 Red Rear
Strobe

 Red Flood
+Dimming

 White
Strobe

 White Spot
+ Dimming

BEAM DISTANCE

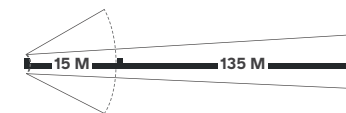

INSIDE THE DESIGN

AlpenGlow Series

High-efficiency LEDs emit broad-spectrum light for more accurate color rendering

CHROMAREAL LED TECHNOLOGY

ChromaReal Technology is a departure from the colder blue lights typically found among many portable lanterns. It helps colors pop and allows finishes to have more depth and luster. ChromaReal is especially helpful with nighttime cooking.

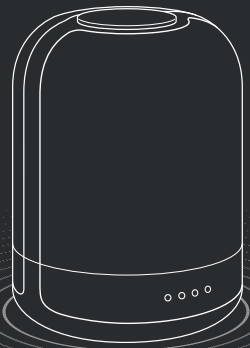





AlpenGlow 500

LNB0100

Feel At Home With Nature-Inspired Light

Inspired by lighting you can only find in the great outdoors, the AlpenGlow lantern gives you the ability to create your own dusk and daylight feel no matter the time of day. Featuring ChromaReal LED technology, accurately render the colors in your environment with the glow of natural light; feeling more aurora borealis? Shake the lantern for an instant rotation of mesmerizing color. Highly responsive to your mood and setting, this lantern steps up the power of ambient lighting through smart tech and thoughtful design.

-  **Cool, Warm, & Color Modes**
-  **ChromaReal LED Technology**
-  **Rechargeable 6,400 mAh Battery Offers Charge Out**



TECH SPECS

LUMENS

500 Lm

BURN TIME (HRS)

48 LO/4.5 HIGH

DIMENSIONS

5.4 x 3.8 in diameter
(136 x 97mm diameter)

INPUTS/OUTPUTS

Micro USB charge in
USB A charge out

BATTERY

6,400 mAh, (22.2 Wh)

WEIGHT

13.8 oz (390 g)

IPX4 RATING

IPX4

LIGHTING MODES

-  Cool light, full (360 degree)
-  Cool light, half (180 degree)
-  Warm light, full (360 degree)
-  Warm Candle Flicker
-  1 color light
-  1 color party mode
-  Multicolor light (preset)
-  Multicolor party mode





AlpenGlow 250

LNA0100

Feel At Home With Nature -Inspired Light

High efficiency meets high ambiance with this nature-inspired portable lantern. Combining ChromaReal LED technology with ergonomic user-friendly design, chose from a mix of warm, cool, and color tones to match the mood of your environment.

-  Cool, Warm, & Color Modes
-  ChromaReal LED Technology
-  Rechargeable 3,200 mAh Battery Offers Charge Out



TECH SPECS

LUMENS

250 Lm

BURN TIME (HRS)

48 LO/4.5 HIGH

DIMENSIONS

3.7 x 3.0 in diameter
(95 x 75mm diameter)

INPUTS/OUTPUTS

Micro USB charge in
USB A charge out

BATTERY

3,200 mAh, (11.1 Wh)









WEIGHT

7.6 oz (215 g)

IPX4 RATING

IPX4

LIGHTING MODES

-  Cool light, full (360 degree)
-  Cool light, half (180 degree)
-  Warm light, full (360 degree)
-  Warm Candle Flicker
-  1 color light
-  1 color party mode
-  Multicolor light (preset)
-  Multicolor party mode





AlpenGlow Mini

● LNC0101
CHARCOAL

● LNC0103
OCEAN TEAL

Nature-Inspired Light In The Palm Of Your Hand

The newest addition to our AlpenGlow line, the AlpenGlow Mini offers multiple lighting modes with ultimate portability. This grab-and-go lantern offers run times of up to 40 hours and versatile hanging configurations thanks to the integrated bungee cord. Available in 4 colors to integrate into a variety of off-grid and on-grid environments.

-  Multiple lighting modes
-  Integrated bungee for hanging
-  Rechargeable 1000 mAh battery



TECH SPECS

LUMENS
150 Lm

BURN TIME (HRS)
40 LO/5 HIGH



IPX RATING
IPX4

INPUTS
USB-C charge in

BATTERY
1000 mAh

WEIGHT
98 g (3.5 oz)

LIGHTING MODES

-  Warm light
-  Single color
-  1 color cycling
-  Multicolor cycling

CHARGE UP TIME
4 hours via USB-C

INSIDE THE DESIGN

Luci Solar Inflatable Lanterns

NEW in 2025. Lightweight, collapsible, and solar powered, the Luci line is designed for adventures, and built to last.



The transformational Luci Lanterns combine power and portability, while utilizing built-in monocrystalline solar technology for reliability. Collapsing down to 1 inch, durable enough to withstand 150 lbs of pressure, and with an IP67 waterproof rating, Luci keeps you out of the dark, no matter how far off the grid you go.

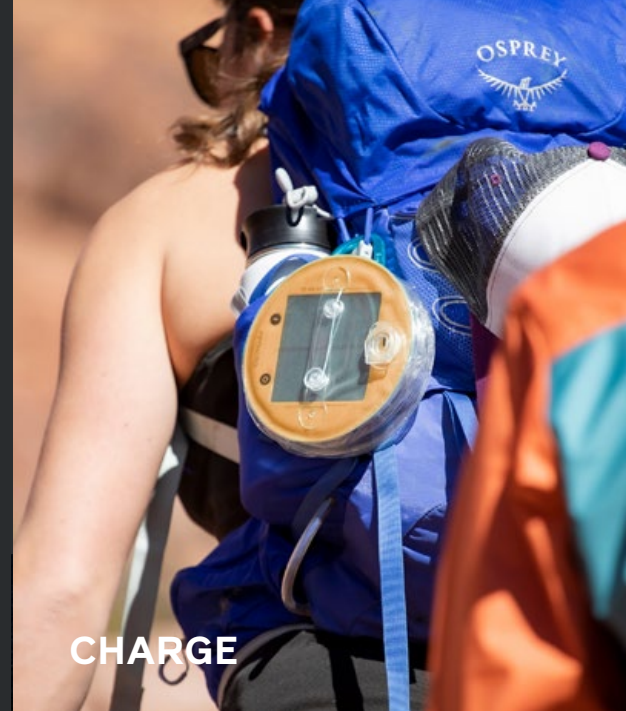
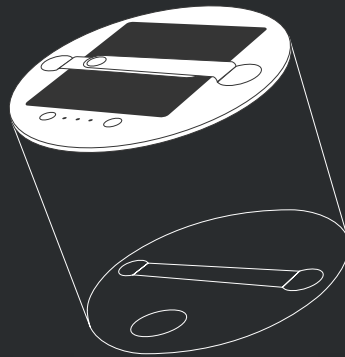

CHARGE



INFLATE



SHINE



Luci Original Clear

NEW IN 2025

LCA0102

Adventure made brighter with Luci

Compact yet powerful, the Luci Original Clear inflatable solar lantern provides up to 24 hours of reliable light on a single charge. Featuring a built-in rechargeable 1,000 mAh lithium-ion battery, emitting up to 75 lumens through a clear finish, and collapsing down to 1 inch, the waterproof Luci Original Clear is built for adventure.

- ☉ Cool LEDs with clear finish
- 📎 Adjustable base strap and fixed top strap
- ⚡ Rechargeable via solar panel or USB-C quick-charge
- ↕ Collapses down to 1 in



TECH SPECS

LUMENS

75 Lm

RUN TIME (HRS)

24 LO/6 HIGH

DIMENSIONS

4.25 x 5 in diameter
(108 x 127mm diameter)
1 in (25mm) collapsed

INPUTS/OUTPUTS

USB-C charge in

BATTERY

1,000 mAh

WEIGHT

4.4 oz (125 g)

WATER RESISTANCE

IP67 rating

LIGHTING MODES

- Low
- Medium
- High
- ☰ Strobe

FINISH

Clear

LEDS

10 cool white







Luci Original Matte

NEW IN 2025

LCA0101

Get cozy with Luci

Functional and stylish, the Luci Original Matte inflatable solar lantern provides up to 24 hours of soft, warm light on a single charge. Featuring a built-in rechargeable 1,000 mAh lithium-ion battery, emitting up to 65 lumens through a frosted finish, and collapsing down to 1 inch, Luci makes on-the-go lighting easier than ever before.

-  Warm LEDs with matte finish
-  Fixed base strap for hanging
-  Rechargeable via solar panel or USB-C quick-charge
-  Collapses down to 1 in

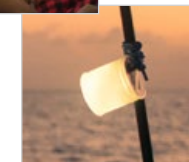

TECH SPECS

LUMENS

65 Lm

RUN TIME (HRS)

24 LO/6 HIGH

DIMENSIONS

4.25 x 5 in diameter
(108 x 127mm diameter)
1 in (25mm) collapsed

INPUTS/OUTPUTS

USB-C charge in

BATTERY

1,000 mAh





WEIGHT

4.4 oz (125 g)

WATER RESISTANCE

IP67 rating

LIGHTING MODES

-  Low
-  Medium
-  High
-  Strobe

FINISH

Matte

LEDS

10 warm white







Luci Original Color

NEW IN 2025

LCA0103

Compact, colorful, and completely solar

With 8 fun color modes to choose from, a color-cycle mode that seamlessly changes from one color to the next, Luci Original Color inflatable solar light transforms any space at the click of a button. Featuring 10 RGB LEDs, a sparkle finish, and collapsing down to 1 inch, Luci Original Color is the perfect way to bring a little color with you wherever you go.

-  Multiple lighting color modes
-  Fixed base strap for hanging
-  Rechargeable via solar panel
-  Collapses down to 1 in



TECH SPECS

RUN TIME (HRS)

Up to 9 hours

DIMENSIONS

4.25 x 5 in diameter
(108 x 127mm diameter)
1 in (25mm) collapsed

BATTERY

1,000 mAh

WEIGHT

4.4 oz (125 g)

WATER RESISTANCE

IP67 rating

FINISH

Sparkle

LEDS

10 RGB

LIGHTING MODES

-  Color cycle
-  Red
-  Green
-  Blue
-  Purple
-  Yellow
-  Cyan
-  Orange
-  White







Luci Charge 150

NEW IN 2025

LCB0100

Go further with Luci Charge 150

With mobile charging capabilities, 150 lumens, and lasting up to 50 hours on a single charge, Luci Charge 150 will take you further than ever before. Featuring a built-in rechargeable 2,000 mAh lithium-ion battery, 10 cool white LEDs shining through a clear finish, and collapsing down to just 1.5 inches, Luci Charge 150 is ready for any adventure thrown at it.

-  Mobile charging capabilities
-  Lasts up to 50 hours on a single charge
-  Rechargeable via solar panel or USB-C quick-charge
-  Collapses down to 1.5 in



TECH SPECS

LUMENS

150 Lm

RUN TIME (HRS)

50 LO/5 HIGH

DIMENSIONS

5 x 5 in diameter
(127 x 127mm diameter)
1.5 in (38mm) collapsed

INPUTS/OUTPUTS

USB-C charge in/out
USB-A charge out

BATTERY

2,000 mAh

WEIGHT

6.1 oz (173 g)

WATER RESISTANCE

IP67 rating

LIGHTING MODES

- Low
- Medium
- High
- Strobe

FINISH

Clear

LEDS

10 cool white







Luci Charge 360

NEW IN 2025

LCC0100

Powerful, portable, and adventure-ready

Extending the day long into night, Luci Charge 360 provides up to 110 hours of reliable light on a single charge. With its built-in rechargeable 4,000 mAh lithium-ion battery, emitting up to 360 lumens via 31 warm white LEDs, and featuring mobile charging capabilities, Luci Charge 360 is a must-have for lighting up any large campsite, backyard, or basement.

-  Mobile charging capabilities
-  Lasts up to 110 hours on a single charge
-  Rechargeable via solar panel or USB-C quick-charge
-  Collapses down to 1.5 in



TECH SPECS

LUMENS

360 Lm

RUN TIME (HRS)

110 LO/5 HIGH

DIMENSIONS

5.4 x 6 in diameter
(137 x 152mm diameter)
1.5 in (38mm) collapsed

INPUTS/OUTPUTS

USB-C charge in/out
USB-A charge out

BATTERY

4,000 mAh





WEIGHT

10.1 oz (286 g)

WATER RESISTANCE

IP67 rating

LIGHTING MODES

-  Low
-  Medium
-  High
-  Strobe

FINISH

Matte

LEDS

31 warm white







Lucii Candle

NEW IN 2025

LCF0100

All the flicker, without the flame

Solar-powered, long-lasting, and flame-free, Lucii Candle provides all the ambiance of a candle with none of the worry. Mimicking candlelight for up to 18 hours on a single charge and flickering through a matte finish, Lucii Candle provides peace of mind where traditional candles cannot.

-  Flame-free flicker
-  Lasts up to 18 hours on a single charge
-  Rechargeable via solar panel
-  Collapses down to 1 in



TECH SPECS

RUN TIME (HRS)

18 LO/10 HIGH

DIMENSIONS

4 x 4 in diameter
(102 x 102mm diameter)
1 in (25mm) collapsed

BATTERY

350 mAh



WEIGHT

2.8 oz (79 g)

WATER RESISTANCE

IP67 rating

LIGHTING MODES

-  Candle flicker
-  Low
-  High

FINISH

Matte

LEDS

1 amber







Luci Emergency

NEW IN 2025

LCE0100

The little light that has your back

Designed for emergencies and built to last, Luci Emergency is the pocket-sized lantern, flashlight, and S.O.S. beacon that is reliable and dependable. Featuring 5 light modes, an IP67 waterproof rating, and collapsing down to just 1 inch, Luci Emergency shines reliably through storms, blackouts, and roadside trouble for up to 7 hours on a single charge.

-  5 lighting modes, including steady red & S.O.S.
-  Rechargeable via solar panel or USB-C quick-charge
-  Matte sides and clear top for ambient light or focused beam
-  Collapses down to 1 in



TECH SPECS

RUN TIME (HRS)

7 LO/3 RED

DIMENSIONS

4 x 4 in diameter
(102 x 102mm diameter)
1 in (25mm) collapsed

FINISH

Matte sides, clear top

BATTERY

600 mAh

WEIGHT

2.8 oz (79 g)





WATER RESISTANCE

IP67 rating

LEDS

3 cool white, 1 red

LIGHTING MODES

-  Low
-  High
-  Strobe
-  S.O.S
-  Steady red

INSIDE THE DESIGN

Solar String Lights

NEW in 2025. Portable, expansive, and solar powered, our String Lights are always ready to hang.

With weatherproof and durable bulbs spread across a nylon-braided cord, our Solar String Lights are perfect for illuminating any space. With the string neatly packed away in the expandable unit, our String Lights can be easily transported wherever you go. Plus, with mobile charging capabilities, the powerful String Lights are the ultimate in overhead lighting. So whether it's a city balcony, a suburban patio, or a cozy campsite, our Solar String Lights turns any outdoor space into a welcoming one.









Solar String 18' Warm White

NEW IN 2025

SSA0101

String up some sun

Solar, portable, and always ready to hang, Solar String 18' White is the perfect way to brighten the backyard or backcountry. These 18 ft nylon-braided string lights pack 100 lumens of power into 10 shatterproof bulbs. Shining for up to 20 hours on a single charge, these string lights are the perfect way to light up your space.

-  18 ft nylon-braided string with 10 durable bulbs
-  Mobile charging capabilities
-  Lasts up to 20 hours on a single charge
-  Rechargeable via solar panel or USB-C quick-charge

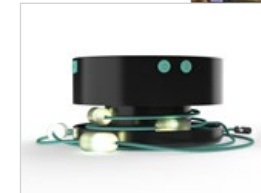

TECH SPECS

STRING LENGTH

18 ft

LUMENS

100 Lm

BULBS

10

LEDS

20 warm white

INPUTS/OUTPUTS

USB-C charge in/out
USB-A charge out

BATTERY

2,000 mAh





RUN TIME (HRS)

20 LO/5 HIGH

WATER RESISTANCE

IPX4 rating

LIGHTING MODES

-  Low
-  Medium
-  High
-  External flashlight

WEIGHT

11.3 oz (320 g)

DIMENSIONS

2 x 5 in diameter
(50 x 127mm diameter)







Solar String 18' Color

NEW IN 2025

SHA0501

String up some color

With 6 unique color modes shining across an 18 ft nylon-braided cord, Solar String 18' Color transforms your surroundings at the click of a button. Featuring 20 RGB LEDs integrated into 10 shatterproof bulbs, you can switch between colors, or simply select the color-cycle mode and seamlessly change from one color to the next. Plus, with rechargeability via solar or USB, these solar string lights are perfect for adding a splash of color to your space.

-  Multiple lighting color modes
-  18 ft nylon-braided string with 10 durable bulbs
-  Mobile charging capabilities
-  Rechargeable via solar panel or USB-C quick-charge

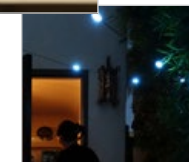

TECH SPECS

STRING LENGTH

18 ft

BULBS

10

LEDS

20 RGB

DIMENSIONS

2 x 5 in diameter
(50 x 127mm diameter)

INPUTS/OUTPUTS

USB-C charge in/out
USB-A charge out

BATTERY

2,000 mAh









RUN TIME (HRS)

15 LO/5 HIGH

WATER RESISTANCE

IPX4 rating

LIGHTING MODES

-  Color cycle
-  Blue
-  Violet
-  Turquoise
-  Green
-  Pink
-  Cool white
-  Flashlight

WEIGHT

11.3 oz (320 g)







Solar String 44' Warm White

NEW IN 2025

SHA0501

On-the-go illumination or permanent ambiance

Powerful and expansive, Solar String 44' White provides up to 40 hours of energy-efficient light on a single charge. With its completely detachable unit, you can remove and recharge the power hub via the solar panel or built-in USB port, all while leaving your string setup intact. Featuring a 48 ft nylon-braided cord, 20 shatterproof bulbs, 40 warm white LEDs, and a 4,000 mAh rechargeable battery with mobile charging capabilities, these solar string lights provide illumination and ambiance to any outdoor space.

-  Detachable 4,000 mAh rechargeable battery
-  44 ft nylon-braided string with 20 durable bulbs
-  Mobile charging capabilities
-  Lasts up to 40 hours on a single charge



TECH SPECS

STRING LENGTH

44 ft

LUMENS

140 Lm

BULBS

20

LEDS

40 warm white

INPUTS/OUTPUTS

USB-C charge in/out
USB-A charge out

BATTERY

4,000 mAh



RUN TIME (HRS)

40 LO/8 HIGH

WATER RESISTANCE

IPX4 rating

LIGHTING MODES

-  Low
-  Medium
-  High

WEIGHT

26.2 oz (745 g)

DIMENSIONS

2.8 x 7 in diameter
(73 x 178mm diameter)





Site Lights

NEW IN 2025 SLD0100

Stake, string, or carry light wherever you need

Featuring 6 hangable lights, 6 ABS stakes, and 1 charging case for storage, Site Lights illuminate any scene for up to 20 hours on a single charge. Whether using the lights independently as “stringless string lights” or connecting onto the stakes to form an illuminated tent peg, the user-friendly design makes using the Site Lights a breeze. From brightening up dinners on the patio to off-grid adventures, Site Lights are the perfect choice for making memories under the night sky.

 6 ABS stakes with 3-sided design for holding power

 6 waterproof bulbs with hanging notch

 User-friendly dual-directional on/off swivel

 1,000 sq. ft. of illumination



TECH SPECS

ILLUMINATION

1,000 sq. ft.

RUN TIME (HRS)

20 LO/6 HIGH

DIMENSIONS

Lights: 2.3 in (6 cm)
Stakes: 6.3 in (16.2 cm)
Case: 7.3 x 2.9 x 3.7 in
(18.5 x 7.3 x 9.4 cm)

INPUTS/OUTPUTS

USB-C charge in

BATTERY

2,600 mAh

STAKES

6 ABS

BULBS

6 weatherproof

LIGHTING MODES

- Low
- Medium
- High

LIGHT CHARGE

6 lights twice on a full battery

LEDS

1 in each light



BioLite Crossover Line

Used by over **8 million people** in off-grid homes around the world, BioLite's SolarHome Series is a groundbreaking system that is changing the landscape of energy access.

Designed for emerging markets, BioLite is proud to offer this crossover line to our outdoor recreation market, a benefit of our unique model of parallel innovation.

SolarHome 625

SHA0501

Multi-Room Solar Light & Power

SolarHome 625 is a self-contained system of solar lighting and charging that can turn any off-grid structure into an electrified home. The system combines easy lightweight overhead lighting, USB charging to small devices, and radio/mp3 capabilities, creating a hub designed for everyday use. Three hanging lights are included for multi-area illumination, one of which includes motion-sensor capabilities perfect for pathways or a little added security. Ideal for cabins, van setups, hunting structures, and emergency kits, the SolarHome 625 is an ideal entry into solar living with easy installation and flexible setup.

- 6 Watt Solar System**
- 3 Hanging Lights, One Includes Option Motion Sensors**
- MP3 & Radio**
- Centralized Control Box With Integrated Light**



TECH SPECS

BATTERY

3800 mAh,
6.4 V (24.3 Wh)

RUN TIMES

- 4 Lights On Low:** 20 hours
- 4 Lights On Med:** 10 hours
- 4 Lights On Hi:** 6 hours

LUMENS

130 Lm in each hanging light
80 Lm control box light
470 Lm total

WEIGHT

Control Box 610 g (1.3 lbs)
Lights (each) 230 g (0.5 lbs)
Solar Panel 720 g (1.6 lbs)

IN THE BOX

- Control Box
- 2 Hanging Lights
- 1 Security/Motion Light
- 1 Solar Panel
- USB Device Adapter (micro, USB-C, 3.5mm DC)
- Mounting Hardware







Solar FlexLight

NEW IN 2025

SFA0100

Light however, and wherever, you need

Task light, emergency light, overhead light, tabletop lamp, Solar FlexLight does it all. With its adjustable 14 inch silicone arm, and 3 cool white LEDs shining through a matte finish, you can direct light however you choose for up to 12 hours on a single charge. Whether you set it up as a lamp, hang it from above, or attach it to your belt, Solar FlexLight has you covered.

-  14" adjustable silicone arm
-  Rechargeable via solar panel or USB quick-charge
-  Lasts up to 12 hours on a single charge
-  Weighs only 124g



TECH SPECS

LUMENS

40 Lm

RUN TIME (HRS)

12 LO/3 HIGH

DIMENSIONS

1.2 x 4 in diameter
(30 x 101mm diameter)
14 in (355mm) arm

INPUTS/OUTPUTS

USB charge in

BATTERY

450 mAh

WEIGHT

4 oz (124 g)

WATER RESISTANCE

IPX4 rating

LIGHTING MODES

- Low
- Medium
- High
- Strobe

FINISH

Matte

LEDS

3 cool white

CHARGE

POWER STATIONS

BaseCharge 1500+

BaseCharge 600+

Cables & Accessories

SOLAR PANELS

SolarPanel 100

SolarPanel 10+

SolarPanel 5+

USB POWERBANKS

Charge 100 Max

Charge 80 PD

Charge 40 PD

Charge 20 PD



BaseCharge 1500+

UPDATED IN 2024



Scale Up Your Off-Grid Power

Looking to power bigger jobs or longer periods of time? Step up to the BaseCharge 1500 and have 1521 watt hours of shareable energy at your fingertips: from medical devices to refrigerators, this high capacity power station can handle hungry devices and an array of electrical requirements. Integrates with BioLite Solar for full solar generator solution and utilizes **Maximum Power Point Tracking** to pull up to 30% more energy than other non-MPPT systems.

- New Fast Charger - 4x Faster Charging Speeds**
- USB-C PD (100 W) and Wireless Charging Included**
- Up to 1200 W (2,400 W Surge) AC output**
- Extra Large Easy-Read Display for Real-time Feedback & Control**
- Safe & Reliable Design With 12 Checkpoint Battery Safety System**



TECH SPECS

<p>BATTERY 1521 Wh (21.6 V, 70.4 Ah) Li-Ion (NMC)</p> <p>INPUTS Wall/Solar Input (HPP): 400 W (10-30 V DC, 20 A max) USB-C PD: 100 W</p> <p>AC OUTPUTS US: (3x) 110 V: Pure Sine Wave, 1200 W, 2,400 W Surge UK/EU/AUS: (3x) 230 V: Pure Sine Wave, 1200 W, 2,400 W Surge</p>	<p>WIRELESS OUTPUT 10W Wireless Charger</p> <p>DC OUTPUTS (1x) 12 V Car Port Output: 120 W (2x) 12 V DC Barrel Ports: 120 W, 5.5 mm OD / 2.1 mm ID</p> <p>USB OUTPUTS (2x) USB-A: 5 V/2.4 A (2x) USB-C: 5 V/3.0 A (1x) USB-C PD: 5 V, 9 V, 12 V, 20 V / 5 A (100 W)</p>	<p>DIMENSIONS 14.4 x 12.2 x 8.2 in 367 x 310 x 209 mm</p> <p>WEIGHT 26.5 lbs 12.1 kg</p> <p>CHARGE TIME 3 hours (Included Wall Charger) 2.5 Hours (Wall Charger + USB-C PD) 3 Hours (Peak Input, 4x SolarPanel 100)</p>
--	---	--



BaseCharge 600+

UPDATED IN 2024



Build Your Own Grid

A high capacity power station ready to keep you charged off-grid, the BaseCharge 600 delivers 622 watt hours of flexible energy to your own personalized ecosystem of devices for an on-grid experience wherever you may be. Integrates with BioLite Solar for full solar generator solution and utilizes **Maximum Power Point Tracking** to pull up to 30% more energy than other non-MPPT systems.

- New Fast Charger - 3x Faster Charging Speeds**
- Up to 600 W (1,000 W Surge) AC Output**
- USB-C PD (100 W) and Wireless Charging Included**
- Extra Large Easy-Read Display for Real-time Feedback & Control**
- Safe & Reliable Design With 12 Checkpoint Battery Safety System**



TECH SPECS

BATTERY

622 Wh (21.6 V, 28.8 Ah)
Li-Ion (NMC)

INPUTS

Wall/Solar Input (HPP):
120 W (10-30 V DC, 10 A max)
USB-C PD: 100 W

AC OUTPUTS

US: (2x) 110 V: Pure Sine Wave, 600 W, 1,000 W Surge
EU/UK/AUS: (2x) 230 V: Pure Sine Wave, 600 W, 1,000 W Surge

WIRELESS OUTPUT

10W Wireless Charger

DC OUTPUTS

(1x) 12 V Car Port Output: 120 W
(2x) 12 V DC Barrel Ports: 120 W, 5.5 mm OD / 2.1 mm ID

USB OUTPUTS

(2x) USB-A: 5 V/2.4 A
(1x) USB-C: 5 V/3.0 A
(1x) USB-C PD: 5 V, 9 V, 12 V, 20 V / 5 A (100 W)

DIMENSIONS

12.2 x 7.9 x 7.9 in
309 x 200 x 201 mm

WEIGHT

13 lbs
5.9 kg

CHARGE TIME

2.5 Hours (Included Wall Charger)
2 Hours (Wall Charger + USB-C PD)
2.5 Hours (Peak Input, 1x SolarPanel 100)

4x1 Solar Chaining Adapter

ACA0103

Looking to concentrate your power generation from the sun? This adapter cable to enables up to 4 BioLite SolarPanel 100s to connect to a single BaseCharge 1500 powerstation creating up to 400W of input for faster recharge times.



TECH SPECS

LENGTH	CONNCECTOR TYPE
14.2 in (360 mm)	1x High Power Pole (HPP) , Output 4x High Power Pole (HPP), Inputs

GAUGE
(4) 16AWG/14AWG

Solar MC4 to HPP Adapter

ACA0101

Looking to pair a BioLite BaseCharge power station with a non-BioLite solar panel? If your panel features an MC4 connector, this adapter is for you. This cord adapts your panel to HPP compatibility, making it ready to work with BaseCharge.



TECH SPECS

LENGTH	CONNCECTOR TYPE
15 in (380 mm)	1x High Power Pole (HPP) , Output 2x MC4 Connectors (+, -), Inputs

GAUGE
16AWG/12AWG

Solar Extension Cable, 15 ft

ACA0104

Looking to bridge some distance between your Solar Panel's sunny spot and where your BioLite BaseCharge powerstation is located? This extension cable will help you keep your power flowing.



TECH SPECS

LENGTH	CONNCECTOR TYPE
15 ft (4.5 m)	1x High Power Pole (HPP), Output 1x High Power Pole (HPP), Input

GAUGE
12 AWG

12 V Car Charger Cable

ACA0102

This adapter cable enables BioLite BaseCharge power stations to recharge from your 12V car port, commonly where lighters used to be located. Ideal for charging on-the-go and when you need an alternative or backup to solar.



TECH SPECS

LENGTH	CONNCECTOR TYPE
10 ft (3 m)	1x High Power Pole (HPP) , Output 1x 12 V Male Carport, Input

GAUGE
18 AWG (15 A fuse)



Charge 100 Max

NEW IN 2024

CBD0100

25,000mAh USB-C PD Power Bank

A power bank designed to keep up with daily life, the Charge 100 Max can power multiple devices at once - and fast. USB-C ports deliver a reliable charge to laptops, earbuds, hotspots and more while the wireless charging keeps phones and tablets running without the need for a cord. Designed for packability and portability, this ultraslim battery delivers the charge you need for life on-the-go.

- ⚡ Full Charge For Most 15" Laptops
- 🔌 Charge Simultaneously With USB-C PD, USB-A & Wireless
- ✈️ FAA Carry-On Compliant
- 📶 Magnetic Wireless Charging



TECH SPECS

BATTERY

91.25 Wh (18.25V, 5,000mAh).
Eq. Capacity: 3.65V, 25,000mAh
1,000 cycles to >70% capacity

WEIGHT

1.3 lbs (580 g)

CHARGE TIME

Under 2 hours by 65W
USB C-PD

DIMENSIONS

5.5 X 4.4 X 1.4 in
(140 x 112 x 35 mm)

OUTPUT POWER

120W total

INPUTS

USB C-PD, up to 65W

OUTPUT PORTS

(2x) 100W USB-C PD
(1x) 15W USB-C
(1x) 15W USB-A
15W MagSafe Wireless





Charge 80 PD

CBC0100

20,000mAh USB-C PD Power Bank

Designed to power the next generation of high-performance personal electronics, Charge 80 PD features USB-C Power Delivery for faster, more flexible charging. Charge compatible laptops, tablets, phones, and more. Compact design is easily packable and ready for travel or life away from an outlet.

-  **USB-C PD for Faster Charging**
-  **Durable Case Construction**
-  **FAA Carry-On Compliant**



TECH SPECS

BATTERY
20,000 mAh, (74 Wh)

CHARGE TIME
5 hrs by up to 18W USB C-PD

**USB A & USB C-PD
POWER OUTPUT**
5V/3.0A, 9V/2A, 12V/1.5A

WEIGHT
16.4 oz (465 g)

DIMENSIONS
8.7 x 3.1 x 0.94 in
(221.5 x 78.3 x 24.0 mm)

INPUTS
USB C-PD, up to 18W

Charge 40 PD

CBA0100

10,000mAh USB-C PD Power Bank

Designed to power the next generation of high-performance personal electronics, Charge 40 PD features USB-C Power Delivery for faster, more flexible charging. Power phones, tablets, and other every day gear. Compact design is easily packable and ready for travel or life away from an outlet.

 **USB-C PD for Faster Charging**

 **Durable Case Construction**

 **FAA Carry-On Compliant**



TECH SPECS

BATTERY

10,000 mAh, (37 Wh)

CHARGE TIME

2.5 hrs by up to 18W USB C-PD

USB A & USB C-PD POWER OUTPUT

5V/3.0A, 9V/2A, 12V/1.5A

WEIGHT

9.4 oz (265 g)

DIMENSIONS

5.5 X 3.1 X 0.94 in
(139.5 x 78.3 x 24.0 mm)

INPUTS

USB C-PD, up to 18W

Charge 20 PD

CBA0100

6,000mAh USB-C PD Power Bank

Designed to power the next generation of high-performance personal electronics, Charge 20 PD features USB-C Power Delivery for faster, more flexible charging. Compact design is easily packable and ready for travel or life away from an outlet.

 **USB-C PD for Faster Charging**

 **Durable Case Construction**

 **FAA Carry-On Compliant**



TECH SPECS

BATTERY

6,000 mAh, (22.2 Wh)

CHARGE TIME

2 hrs by up to 18W USB C-PD

USB A & USB C-PD POWER OUTPUT

5V/3.0A, 9V/2A, 12V/1.5A

WEIGHT

5.8 oz (165 g)

DIMENSIONS

4.4 X 2.0 X 0.98 in
(112.3 x 51.0 x 24.8 mm)

INPUTS

USB C-PD, up to 18W

INSIDE THE DESIGN

SolarPanel Series

The most from the sun
in minimalist form

OPTIMAL SUN SYSTEM

BioLite's SolarPanel Series pairs user-centric design with minimalist materials to create a more powerful charge. Instead of cumbersome casings and plastics, our proprietary panel-bonding design allows us to feature a sun-optimizing kickstand and sundial while maintaining an ultraslim, packable profile.

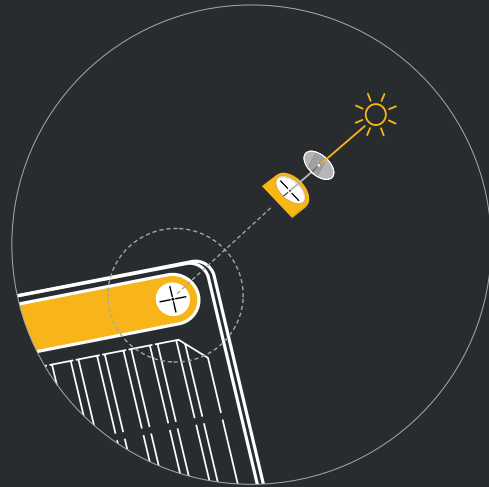



SolarPanel 100

SPD0100

Highly Powerful, Highly Packable

The BioLite SolarPanel 100W is a 100 watt, lightweight, chainable solar panel that offers serious power and ultimate packability for your off-grid activity. The sleek ETFE laminated construction enables the high efficiency monocrystalline cells to run at peak performance without any unnecessary bulk or materials while simultaneously providing protection from surprise showers. Power devices directly through the integrated USB-A and USB-C PD ports or pair with the BioLite Power Station for a full solar generator solution.



Optimal Sun System Sets Panel Up for Direct Rays via Integrated Sundial and Kickstand



92 in² of Surface Area Packs Down to 20x15x1.5 in With Easy-Carry Handles



Durable and Water Resistant, With Storage Pouch for Added Protection



Works with BioLite or non-BioLite Stations using a standard connector



Compatible With 4x1 Chaining Adapter Cable for up to 400W Solar Generator



TECH SPECS

WEIGHT

9.5 lbs (4.3 kg)

OUTPUTS

High Power Pole (HPP)
Powerstation connection
USB-C PD, 45 W
2x USB-A

POWER OUTPUT

100 W in Peak Sunshine

DIMENSIONS (FOLDED)

20.1 x 14.3 x 1.5 in
(50.8 x 36.3 x 3.8 cm)

DIMENSIONS (UNFOLDED)



20.1 x 57.5 x 1.0 in
(50.8 x 146.0 x 2.5 cm)

SolarPanel 10+

SPC0200

10 Watt Panel with Power Storage

Looking for more power? Double-down with the folding SolarPanel 10+ and enjoy the same optimizing benefits of the 5+, but with twice the output. Thanks to minimalist construction, the folding design maintains a small footprint, slipping easily into laptop sleeves for ultimately portability.

-  Real Time Power
-  On-Board 3,200 mAh Battery
-  Sundial For Optimal Alignment
-  Ultraslim Fold-Flat Design



TECH SPECS

WEIGHT

1.23 lbs (558 g)

INPUTS/OUTPUTS

Micro USB charge in
USB charge out

DIMENSIONS (FOLDED)

10.12 x 8.19 x 0.94 in
(257 x 208 x 24 mm)

BATTERY

3,200 mAh

POWER OUTPUT

10 watts

WEATHER RESISTANCE





IPX4

SolarPanel 5+

SPA0200

5 Watt Panel with Power Storage

Featuring BioLite's Optimal Sun System, an integrated sundial aligns you to the sun to capture direct rays and a 360 degree kickstand simplifies positioning on uneven terrain. Designed to put you in control of your energy, Maximum Power Point Tracking helps you get the strongest charge under all conditions while the 3,200 mAh on-board battery stores power, enabling you to charge devices when you need it most.

-  Real Time Power
-  On-Board 3,200 mAh Battery
-  Sundial For Optimal Alignment
-  Ultraslim Design



TECH SPECS

WEIGHT

0.86 lbs (390 g)

INPUTS/OUTPUTS

Micro USB charge in
USB charge out

DIMENSIONS

10.12 x 8.19 x 0.94 in
(257 x 208 x 24 mm)

BATTERY

3,200 mAh

POWER OUTPUT

5 watts

WEATHER RESISTANCE

IPX4



PORTABLE STOVES

CampStove Complete Cook Kit

CampStove 2+

CampStove KettlePot
& Coffee Set

CampStove Portable Grill

CAMPFIRE EVOLVED

FirePit+

FirePit Grill Lid

FirePit Griddle

FirePit Carry Bag

Prep & Grill Toolkit

FirePit Poker

FirePit Mat

INSIDE THE DESIGN

CampStove Series

BioLite's origin story centers around a technology that turns fire into electricity - and creates a much cleaner burn in the process.

CLEAN COMBUSTION TECHNOLOGY

BioLite's patented design converts **heat** from your fire into usable **electricity**, powering an internal **airflow** system that optimizes combustion, burning smoke before it has a chance to escape.

Surplus electricity is stored in the onboard battery, enabling you to access power via USB when you need it.

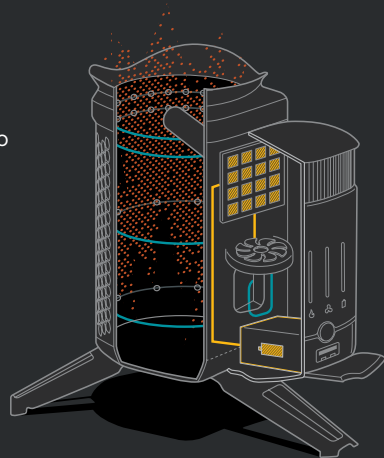



CampStove Complete Cook Kit

BNA0100

Portable Wood Cooking System

Cook, boil, grill, and charge with this outdoor camp kitchen. Generate electricity and create smokeless wood flames with the award-winning CampStove 2+ while cooking up meals and beverages with the Portable Grill, KettlePot, and Coffee Press accessories. Featuring an updated 100 lumen FlexLight with ChromaReal LED technology, cook with confidence at night thanks to accurate color rendering.



On-Demand Electricity



Runs On Sticks Or Pellets



Create Full Meals
& Hot Beverages



100 Lm ChromaReal
FlexLight Included



TECH SPECS

TOTAL WEIGHT
4.94 lbs (2.25 kg)

INCLUDED IN BUNDLE
CampStove 2+
CampStove Portable Grill
CampStove KettlePot
KettlePot Coffee Press
FlexLight 100







CampStove 2+

CSC0200

Turn Fire Into Electricity

Turn fire into electricity with BioLite's award-winning wood stove. Patented thermoelectric combustion technology creates a vortex of smokeless flames for a portable campfire that can cook your meals and charge your gear. Featuring an updated 100 lumen FlexLight with ChromaReal LED technology, cook with confidence at night thanks to accurate color rendering.



-  3200 mAh Integrated Battery
-  100 Lm ChromaReal FlexLight Included
-  Extra Storage Stuffsack
-  Smart LED Dashboard
-  Smokeless Flames

TECH SPECS

BATTERY

3,200 mAh

FLEXLIGHT (INCLUDED)

100 lumens

FUEL

Renewable biomass
(twigs, sticks, pellets)

WEIGHT

2.06 lbs (935 g)

BOIL TIME

4.5 minutes for 1 L

USB OUTPUT

1x USB A, 5V / 2.0A

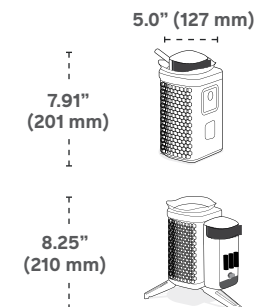

CampStove KettlePot & Coffee Set

BNA0101

Camping Stove Cookware Accessory

Cook meals, boil water, and make coffee with this quick cooking system. Designed for use with the BioLite CampStove, the KettlePot cooks like a pot and pours like a kettle while the included CoffeePress delivers french-press style brewing. When not in use, KettlePot doubles as a hard-carry case for your CampStove, saving space in your pack and offering extra protection.



Featherlite and Food safe



Make 6 Cups of Coffee

TECH SPECS

MATERIALS

Stainless steel, silicone, plastic

WEIGHT

1.02 lbs (465 g)

MATERIALS

BPA-free polypropylene

VOLUME

Boils 1-6 cups

CampStove Portable Grill

CSD0200

Tabletop Grill For CampStove

Cook your favorite meals over wood with one of the lightest tabletop grills on the market. Transform your BioLite CampStove 2 into a wood-fired grilling surface with this seamless and fun attachment.



Portable and Light



TECH SPECS

COOKING AREA

55 sq inches

WEIGHT

1.875 lbs (850 g)

FOLDED SIZE

9.5 x 12 x 3.5 in
(24.13 x 30.48 x 8.89 cm)

UNFOLDED SIZE

9.5 x 12 x 10.5 in
(24.13 x 30.48 x 26.67 cm)

INSIDE THE DESIGN

FirePit+

The secret to a better fire?
Burn the smoke. Smoke is just
unburned fuel that has escaped
your fire - we don't let that happen.

 CLEAN COMBUSTION TECHNOLOGY

BioLite technology creates a carefully calibrated airflow, using an internal fan to inject oxygen into the fire. With 51 air jets distributed across the FirePit's burn chamber, the result is a highly efficient and complete burn.

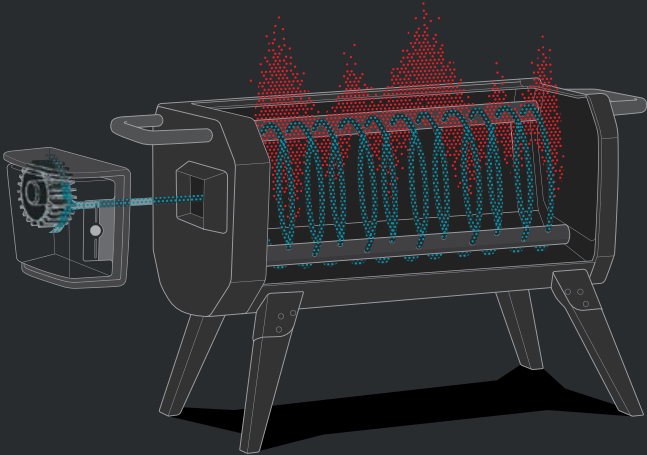



FirePit+

FPA0201

See Fire, Not Smoke

With capacity for up to four standard firewood logs, the BioLite FirePit creates a hyper-efficient burn with patented airflow technology and gives you a front-row seat to the magic thanks to the X-Ray Mesh Body, enabling 360 views. Lift the fuel rack and toss in charcoal to transform the FirePit into a hibachi-style grill, complete with an included grill grate.

 **12,800 mAh Battery**
For Longer Run Times

 **High-Temp Enamel Coating**

 **X-Ray Mesh For 360° Viewing**

 **Use Wood or Charcoal**

 **Bluetooth Enabled**



TECH SPECS

BURN TIME

Fan Low: 30 Hours
Fan Medium: 14 Hours
Fan High: 7 Hours

FUEL

Firewood or charcoal

WEIGHT

19.8 lbs (8.98 kg)

COOKING SURFACE

130 in² (822 cm²)

INPUTS/OUTPUTS

Micro USB/USB A

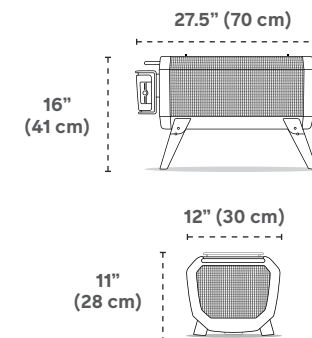

FirePit Grill Lid

FPF0100

Turn your FirePit Grill into a wood-fired oven and take your outdoor cooking to the next level. Featuring enamel coated stainless steel construction, this durable accessory integrates with the FirePit to concentrate heat for both low-and-slow and quick-grill cooking methods.



TOTAL WEIGHT

3.9 lbs
(1.77 kg)

MATERIALS

Enamel-coated steel

DIMENSIONS

22.0 x 12.6 x 6.3 in
(56 x 32 x 16 cm)

FirePit Griddle

FPE0100

Designed to perfectly fit the FirePit, this cast iron griddle will transform the way you do breakfast outside. A pre-seasoned nonstick surface means great meals from the very first sizzle while the raised edges help contain grease and other runoff. May be used on its own or pair with the FirePit OvenTop (sold separately) for even more concentrated cooking.



TOTAL WEIGHT

8.8 lbs
(3.98 kg)

MATERIALS

Nonstick cast iron

DIMENSIONS

19.3 x 9.5 x 19.7 in
(49 x 24 x 50 cm)

FirePit Carry Bag

FPD0100

Make transport and storage a breeze with this carry bag custom designed to fit the FirePit and all of its accessories. The fully encased design means you can throw your FirePit in the back of your car without worry of ash or cooking leftovers touching your interior. The bag also works as a firewood sling so you can have fuel at the ready.



MATERIALS

Heavy duty canvas

DIMENSIONS

24 x 16 x 12.5 in
(61 x 41 x 32 cm)

Prep & Grill Toolkit

BNB0101

Packable tools designed for cooking with fire. The extra long design provides comfortable distance from flames and heat while the roll-up organizational mat keeps everything in order. Made of durable and rust-resistant food grade stainless steel.



INCLUDES

Santoku knife, Slotted turner,
Locking tongs, Tool roll

MATERIALS

Heat resistant stainless steel, nylon

FirePit FirePoker

FAB0200

The poker's broad flat edge helps stoke fuel and ensure logs are properly stacked for ideal airflow while the curved point hooks onto the FirePit's fuel rack for easy adjustment to the charcoal or wood setting.



MATERIALS

Stainless steel, silicone rubber

DIMENSIONS

23.4 x 2.2 x 0.5 in
(59 x 5.6 x 1.4 cm)

WEIGHT

148 g (5.2 oz)

FirePit FireMat

BNB0101

The FireMat is designed to reflect radiant heat, making it an ideal solution for decks, patios, lawns, and other sensitive surfaces. The FireMat packs up easily and is ready for your next burn.



MATERIALS

Aluminum coated fiberglass fabric

DIMENSIONS

31.8 x 24.0 in
(80.8 x 61.0 cm)

WEIGHT

450 g (16 oz)

BioLite 2025 Product Assortment

LIGHT

HEADLAMPS

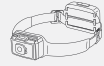

HeadLamp 800 Pro

● HPC0201



Dash 450

● HPA0411
● HPA0410
● HPA0412



HeadLamp 325

● HPB0310
● HPB0311
● HPB0312

INSTALLED SOLAR



SolarHome 625

SHA0501

USB LANTERNS



AlpenGlow 500
LNB0100



AlpenGlow 250
LNA0100



AlpenGlow Mini

● LNC0101
● LNC0103

SOLAR UTILITY



Solar FlexLight
SHA0501

SOLAR INFLATABLE LANTERNS



Luci Original

● Matte: LCA0101
● Clear: LCA0102
● Color: LCA0102



Luci Charge 150
LCB0100



Luci Charge 360
LCC0100



Luci Emergency
LCE0100



Luci Candle
LCF0100

SOLAR STRING LIGHTS



Solar String 18'

● Warm White: SSA0101
● Color: SSA0102



Solar String 44'

● Warm White: SSB0101
● Color: SSB0102



Site Lights
SLD0100

CHARGE

POWER STATIONS



BaseCharge 1500+

● BGB0201 ● BGB0203
● BGB0202 ● BGB0204



BaseCharge 600+

● BGA0201 ● BGA0203
● BGA0202 ● BGA0204

SOLAR PANELS

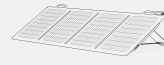

SolarPanel 100+
SPD0100

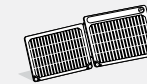

SolarPanel 10+
SPC0200



SolarPanel 5+
SPA0200

BATTERY BANKS



Charge 100 Max
CBC0100



Charge 80 PD
CBC0100



Charge 40 PD
CBB0100



Charge 20 PD
CBA0100

COOK

PORTABLE STOVES



CampStove Complete Cook Kit

BNA0100



CampStove 2+

CSC0200



CampStove KettlePot & Coffee Set

BNA0101



CampStove Portable Grill

CSD0200

CAMPFIRE EVOLVED



FirePit+
FPB1001



FirePit Grill Lid
FPA0201

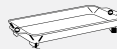

FirePit Griddle
FPE0100



FirePit Prep & Grill Toolkit
BNB0101



FirePit Carry Bag
FPD0100



FirePit Poker
FAB0200



FirePit Mat
FAA0200

Training & Support

Training Guides & Videos

We want to help retail employees better understand the BioLite ecosystem. With every new product launch, we offer training videos and quick reference guides created with retail employees in mind. Visit our new Envoy Training Showroom for videos and product orientations.

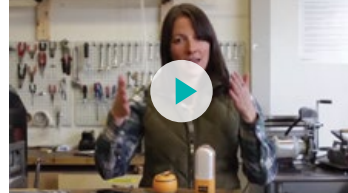

Marketing Support

We maintain a rich library of assets to support your marketing efforts. From ambassador photography to Facebook-friendly videos and SEO optimized blog content, our team is ready to support social and digital efforts.

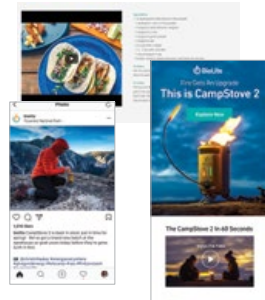

Brand Guidelines

Visit [BioLiteEnergy.com/brand](https://www.BioLiteEnergy.com/brand) to download fonts, logos, product imagery and additional creative assets.



Point-Of-Purchase

Product POP



BaseCharge Series

Works with all BaseCharge series models



CampStove 2+ PDA0101

6.9 x 10.7 in
(17.5 x 27.2 cm)



FirePit+ PDA0102

20.5 x 7.2 x 2
(52 x 18 x 5 cm)

Signage



12x36" Logo Signage PDB0101

12 x 36 in
(30.5 x 91.4 cm)
Adhesive tape included for installation



6 x 18" Logo Signage PDB0102

6 x 18 in
(15.2 x 45.7 cm)
Adhesive tape included for installation



5x11" Cook/Charge/Light Category Signage PDB0103

5 x 11 in
(12.7 x 27.9 cm)
Adhesive tape included for installation

Glossary Of Terms

Power (Watts [W])

Power describes the amount of instantaneous energy available to operate or charge a device, typically measured in Watts [W]. In BioLite products, we use Watts to describe how much energy you can generate from our Solar Panels and Thermoelectrics. This energy is most often used to fill the batteries of other devices. Typically, the more powerful (higher watts) a power source is, the faster it will charge other devices.

Power Storage (Watt Hours [Wh] or Milliamp Hour [mAh])

The capture of energy produced at one time for use at a later time - generally in a battery. BioLite devices like the CampStove, BaseCamp, SolarPanel Series, Charge Series and Lanterns contain highly efficient, compact, Lithium Ion batteries for power storage.

Lumens

The amount of light emitted per second in a unit solid angle from a uniform source in all directions. Essentially lumens measures the brightness of a light source.

Thermoelectrics

A fundamental physical property of certain semiconductor materials that directly convert heat flows into electricity. Thermoelectrics are solid-state (meaning no moving parts) and work for many years without degradation. BioLite uses thermoelectrics in the CampStove and BaseCamp to turn fire into electricity.

Parallel Innovation

BioLite develops core energy technologies that are applicable to both Outdoor and Emerging Markets. We then design products unique to the customer needs in each respective market. Profits from our Outdoor Markets are reinvested into our Emerging Markets in order to help us reach self-sustaining scale in Emerging Markets. You can think of it as an alternative to venture capital investment, where our Outdoor customers become the catalysts for energy access to the people who need it most. This is not charity, as our customers in Emerging Markets still pay for products, but rather catalytic investment to help us launch a business which can reach millions of people with clean, affordable energy.

Maximum Power Point Tracking (MPPT)

MPPT is the most advanced type of solar converter circuit available. Unlike rudimentary controllers (such as PWM) the MPPT controller is constantly measuring the panel operating point and balancing circuit loads to maximize power transfer to the battery under all sun conditions. The result is up to 30% more energy transferred in a given day.

ANSI FL-1

This standard is a set of flashlight and headlamp performance guidelines. ANSI FL-1 allows for direct comparisons can be made between lighting products from different manufacturers. Adherence to the FL1 Standard is voluntary, although the vast majority of manufacturers have adopted the standard. Ratings are defined for the following performance criteria:

- Light Output [Lumens]
- Peak Beam Intensity [Candela]
- Beam Distance [Meter]
- Runtime [Hours]
- Water Resistance [IPX Rating]

USB-C PD (Power Delivery)

Power Delivery (PD) is a protocol specification that allows for fast, flexible and safe charging. This technology allows a variety of devices to fast charge over a common USB-C connection and allows both power-providing and power-receiving devices to negotiate the most efficient and safe setting.

ChromaReal

ChromaReal is an LED technology that BioLite uses for applications where complete and accurate lighting is important. Any product with ChromaReal will have a Color-Rendering Index (CRI) of 90 or higher. The CRI is a measure of how full spectrum the emitted light is and how accurate colors will appear.

3D SlimFit

3D SlimFit refers to BioLite's proprietary construction method for headlamps, integrating electronics directly into softgoods for an unprecedented fit and profile. The "3D" refers to 3 dimensions identified for high-performance fit: 1) flush, low-profile front housing for no bounce; 2) distributing weight across the headlamp for a more natural feel; and 3) moisture-wicking fabrics that keep the user cool and dry during activity.

Pure Sine

Pure Sine technology is a specific type of power inverter that turns DC power from a battery into AC power. AC (Alternating Current) is what's provided by the grid to your home outlets and needs to have a specific sine wave frequency to be compatible with all devices (such as newer TV's, CFL light bulbs, and some appliances with AC motors). Older or lower quality Power Stations use a "modified sine" approach that can cause issues with these devices and in many cases an annoying humming noise.

BioLite Dealer Inquiries

Want to become a BioLite dealer or place a new order? Please follow one of these links to fill out a form with your details and we will follow up with you.

Alternatively you can also reach out to us at sales@bioliteenergy.com.



Dealers.BioliteEnergy.com



DealersCanada.BioliteEnergy.com



DealersEurope.BioliteEnergy.com

DealersAsia.BioliteEnergy.com

